

Measumax

Digital Disk Micrometers 45-502, 45-503

OPERATION MANUAL

1. Functional elements

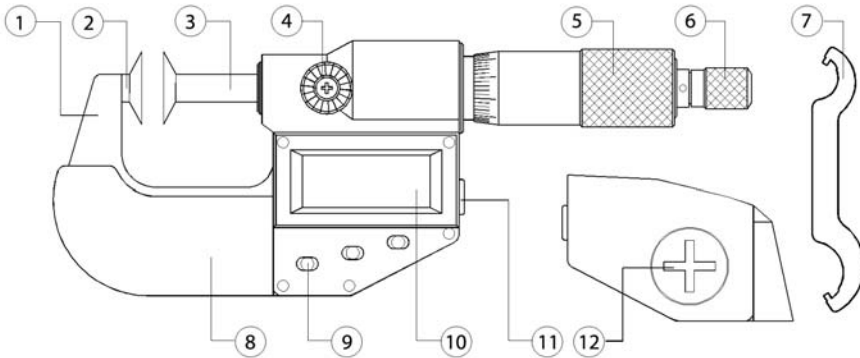

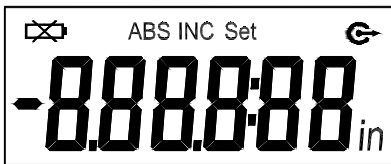

- 1. Frame
- 2. Anvil
- 3. Spindle
- 4. Locking device
- 5. Scale reading device
- 6. Ratchet stop
- 7. Spanner
- 8. Frame cover
- 9. 3 keys
- 10. LCD display
- 11. RS232 Data output
- 12. Battery cap

2. LCD Display



- in:** Inch measuring mode
- INC:** Relative measuring mode
- ABS:** Absolute measuring mode
- Set:** Origin set

- : Battery voltage is low.
- : Data Output is going.
- :**: Clock mode. The left two figures is hour. The right two figures is minute.

3. Operation:

Ways of pressing keys are as follows

- (1) Press and release (less 2 sec.).
- (2) Prolonged time, press and hold (2 sec. or more).

3.1 ON/OFF & SET key: This key acts as both a Power switch, and origin data set

Press and release= Power on/off.

Press and hold (2 sec. or more): = Used for setting the origin data for absolute measurement. The "Set" sign will be displayed on LCD at this time..

Origin of metric can be 0, 25, 50, 75...275mm.

Origin of inch can be 0", 1", 2", 3" ...11".

Reset origin according to the process in Chart 1 after resetting the battery.

For the instrument with the range of 25~50mm, set origin according to the process in Chart 2.

(3.1.1) Process of setting origin data for absolute measurement. See Chart 3.

a. Press and hold (2 sec. or more): "Set" sign blinks and setting origin data can commence.

b. According to the origin data, press and hold for (2 sec. or more) the "Set" key, the display increases by 25 in metric and by 1" in inch, When the right data display, release the key.

Origin of metric is 0, 25, 50, 75 to 275, 0.

Origin of inch is 0, 1", 2", 3" 4" to 11", 0.

c Press and hold (2 sec. or more):and the "Set" sign will start to blink on the LCD. Displayed data is the origin data of the absolute measurement after you press and release the key.

Preset mode is canceled by pressing "ON/OFF & SET" key and the system will return to the ABS mode.

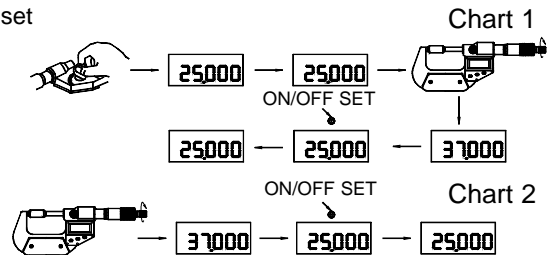

3.1.2 Enter measurement state of set origin data for absolute measurement (Setting origin data as 25). See Chart 4.

Press and hold (more than 2 sec.): Display set origin data for absolute measurement.

Set value will be retained if the power is OFF. Preset value will be "0" after replacing the battery, reset origin data in "Set" mode.

Origin data is metric in metric measuring mode.

Origin data is inch in inch measuring mode.

Notice: The processes of 3.1.1 and 3.1.2 are only for the following electronic micrometers: Depth micrometers, Gear root diameter micrometers, Interchangeable-anvil micrometers, Adjustable-anvil micrometers, Slide-anvil micrometers with indicator.)

3.2 ABS/INCoooUNIT key: Absolute and relative measuring conversion. Metric-inch conversion in prolong time.

Press and release: Absolute and relative measuring mode conversion."INC" sign displayed on LCD in relative measuring mode, otherwise absolute measuring mode.

Press and hold (2 sec. or more): Metric/inch conversion."in" sign displayed on LCD for inch, otherwise mm.

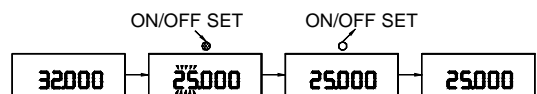
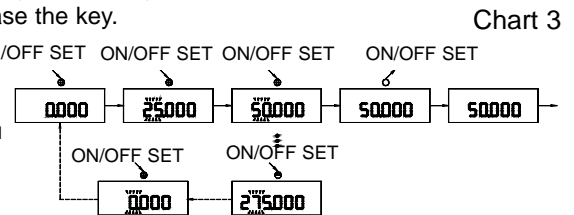

3.3 \ominus/\oplus Data output and clock switch key.

- The micrometer will output the displayed data and display " \ominus " on LCD once when the button is pressed once.
- Pressing and holding (2 sec. or more) the button, will output the data and display " \ominus " continually until the button is pressed again.

Press " \ominus/\oplus " key again and the clock mode will display the current time after power off the micrometer by pressing "ON/OFF...SET" key.

Set clock Switch off the clock by pressing " \ominus/\oplus " key.

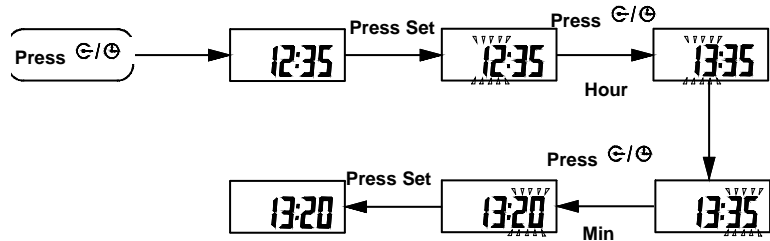

The micrometer is measuring mode by pressing "ON/OFF...SET" key.
Preset time will be lost after resetting the battery.

4. Power

Use a SR44 battery. Replace the battery when display data is blurring or " \times " sign displays on LCD.
If the instrument is not used in about five minutes, the power will auto shut-off. The micrometer can be activated again by pressing the "ON/OFF...SET" key or by turning the spindle.
Power off the micrometer by pressing "ON/OFF...SET" key to save battery if not use.
To remove the battery undo the cap by turning it counterclockwise with a coin or a spanner.
Put a new battery with the positive (+) side up. Secure the battery cap by turning it clockwise.

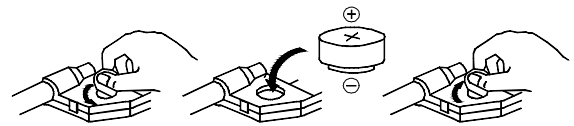

5. Data output

Data output interface is RS232C.
The micrometer can be connected to PC's serial port by SPC cable (Order No. 40-400) or to PC's USB port by SPC cable and USB to serial port Cable (Order No. P1201).
Remove the cap of the output connector and insert the cable. (To remain IP54 compliant the plug cover must be in place when the cable has been removed)

5.1 Serial port format

Baud rate	1200kB/S	Stop bit	2
Start bit	1	Parity	none
Data bit	7	Data logic	reverse

5.2 Data output format

Order	1	2	3	4	5	6	7	8	9	10
Metric	S	N1	N1	N	1 £	N	N	N	CR	LX
Inch	S	N	1 £	N	N	N	N	N	CR	LX

S:Minus or Space N1:Minus or Space or digit 0-9 N:Digit 0-9

6. Specifications

Measuring force : 5~10N Power consumption: <=35µA Operating temperature: 0 ~ 40? Storage temperature: -20 ~ 60?

7. Precautions

Do not subject the instrument to blows or knocks. Do not drop it or apply excessive force to it. Do not disassemble the instrument.
The spindle is designed so that it cannot be removed from the inner sleeve. Do not move it past the upper limit of the measuring range.
Do not press the key with a pointed object. Press the key along its moving direction, otherwise it will affect the key's sensitivity.

Do not use or store the instrument under direct sunlight, or in an excessively hot or cold place.

Do not let the instrument near strong magnetic field and high voltage.

Use a soft or a cotton swab that is dry to wipe stains off the instrument. Do not use organic solvent such as acetone and benzene. Wipe measuring faces of the instrument before use it.

Remove the battery if the instrument not used for a long time. Protection level IP54.

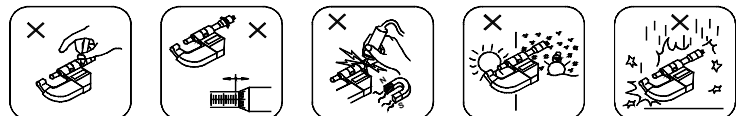

8. Trouble shooting

Failure	Causes	Repairing
Display "E 1" on LCD.	Data overflow.	Move spindle reverse to recall the display or press "SET" key to reset origin data.
Display "E 3" on LCD.	1. Sensor overflow. 2. Something wrong with sensor.	1. Reset battery. 2. Return the micrometer for repair.
Measuring data is not correct.	1. Dirty measuring surfaces. 2. Preset data isn't correct.	1. Clean measuring surfaces. 2. Inspect preset data and reset it.
No display on LCD.	1. Battery is not properly set. 2. Battery doesn't work.	1. Reset battery. 2. Replace battery.
1. Display isn't steady. 2. Display is confusing. 3. Display remains dead.	1. Battery voltage under 1.45v. 2. Battery voltage under 1.45v. 3. Battery is not properly set.	1. Replace battery. 2. Replace battery. 3. Reset battery.
1. Display blurring. 2. The output data is wrong.	Battery voltage under 1.45v.	Replace battery.